



EAN: 8020283034174

No: 5937

MISSY PB IX/A/90

By Elica

Stål

Vægmonteret emfang. Med intern motor - 900 mm

Specifikationer

Luftstrøm: 165 - 395 m³/t

Lydeffekt: 49 - 68 dB(A)

Belysning: 2 x 3 (LED) W

Betjeningspanel: Pushbutton

Antal niveauer/trin: 3 trin

Energiklasse: **D** E (Air) C (Light) D (Filter)

Mål (H x B x D)

Produkt (BxDxH): B: 900 mm D: 450 mm H: 739 - 1061 mm

Luftudtag: Ø150 mm

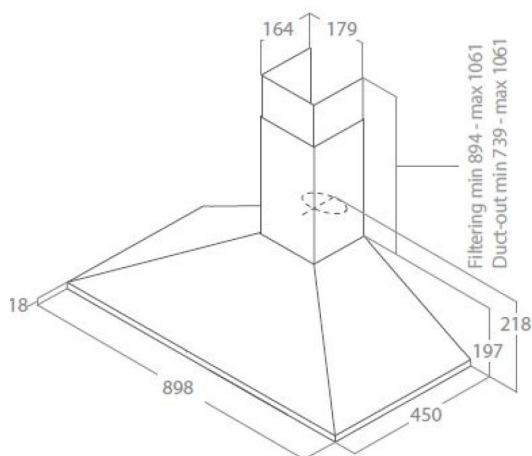

HighLights

- Klassisk stilren vægmonteret emhætte
- Lavt lydniveau
- Nem rengøring